

**Dimension Sketch:**

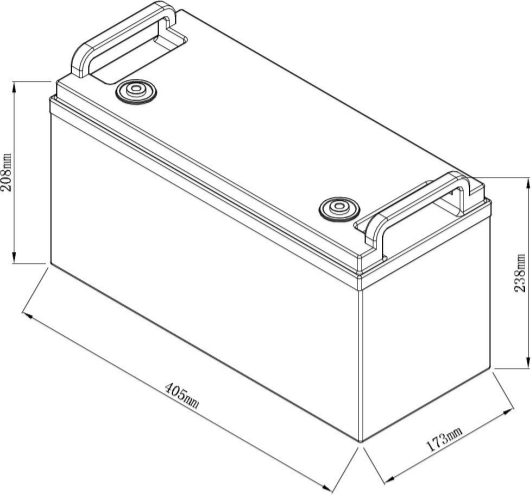

**Appearance:**



**Terminal:**

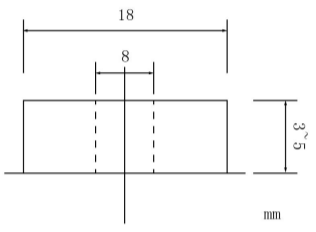

**MP-4860**

51.2V60Ah

Rated Voltage:	51.2V
Rated Capacity:	60Ah
Rated Energy:	3072Wh
Max. Charge Voltage:	58.4V
Max. Charge Current:	60A
Float-Charge Voltage:	54.4~55.2V
Max. Discharge Current, :	80A
Peak discharge current@10s:	150A
Max. Load Power:	3000W
Discharge Cut-off Voltage:	43.2V
Charge Temp.:	0~+50°C
Discharge Temp.:	-20~+60°C
Working Humidity:	<95%R.H (non-condensing)
Cycle Life (25°C,0.5C,100%DOD):	>2000
Cell configuration:	23140160-16S1P
Terminal:	F12(M8)
IP Grade:	IP65
Dimension:	405*173*208 (238) mm
Weight:	21Kg
Certificates:	UN38.3/MSDS

**Different Rate Discharge Curve**

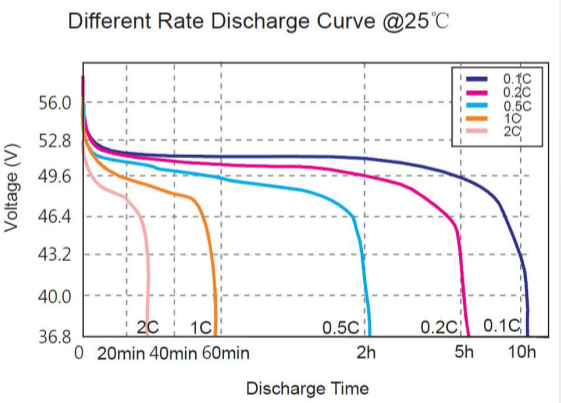

**Different Temperature Discharge Curve**

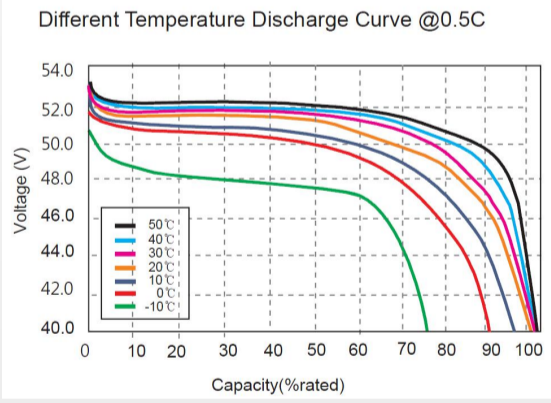

**State of Charge Curve**

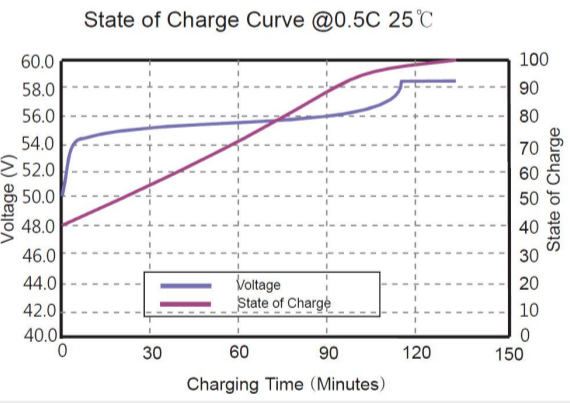

**Charging Characteristics**

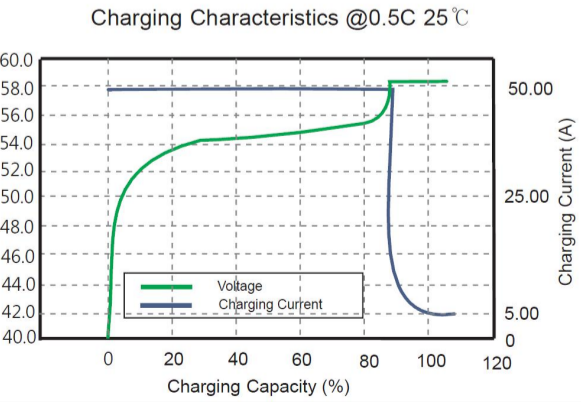

**Cycle Life Curve**

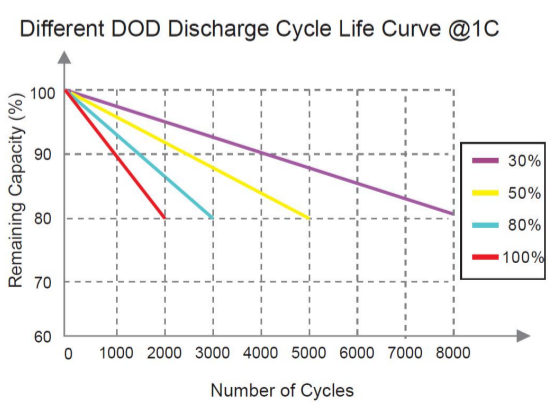

**Self Discharge Characteristics Curve**

