

Dimension Sketch:

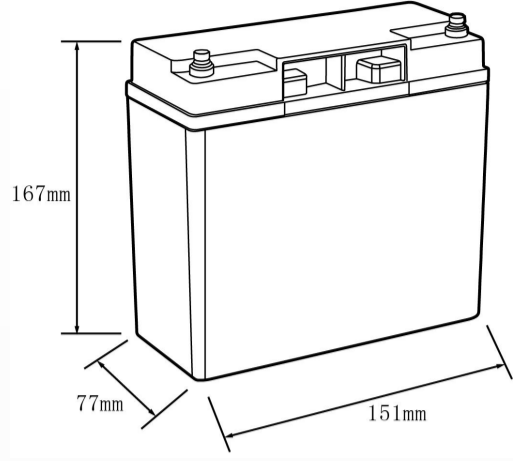

Appearance:



Terminal:

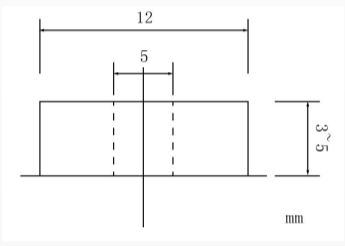

MP-1220

12.8V20Ah

Rated Voltage:	12.8V
Rated Capacity:	20Ah
Rated Energy:	256Wh
Max. Charge Voltage:	14.6V
Max. Charge Current:	20A
Float-Charge Voltage:	13.6~13.8V
Max. Discharge Current, :	30A
Peak discharge current@10s:	60A
Max. Load Power:	300W
Discharge Cut-off Voltage:	10.8V
Charge Temp.:	0~+50°C
Discharge Temp.:	-20~+60°C
Working Humidity:	<95%R.H (non-condensing)
Cycle Life (25°C,0.5C,100%DOD):	>2000
Cell configuration:	32700-4S4P
Terminal:	F13(M5)
IP Grade:	IP65
Dimension:	181*77*167mm
Weight:	2.1Kg
Certificates:	UN38.3/MSDS

