

Dimension Sketch:

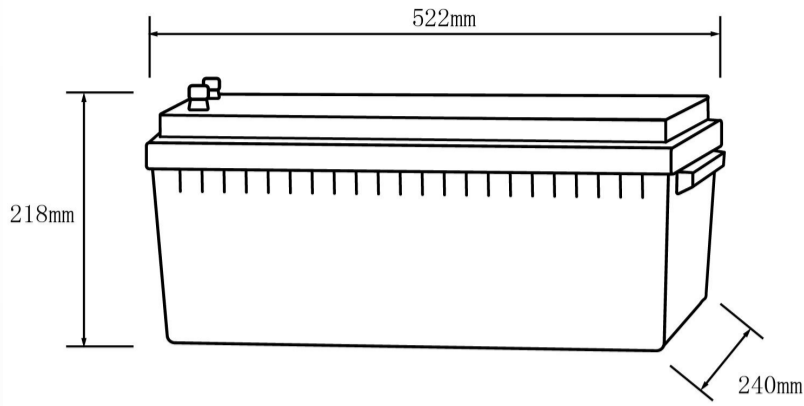

Appearance:



Terminal:

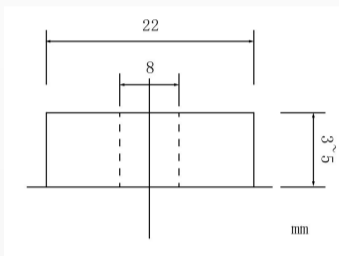

Rated Voltage:	12.8V
Rated Capacity:	200Ah
Rated Energy:	2560Wh
Max. Charge Voltage:	14.6V
Max. Charge Current:	100A
Float-Charge Voltage:	13.6~13.8V
Max. Discharge Current, :	100A
Peak discharge current@10s:	200A
Max. Load Power:	1000W
Discharge Cut-off Voltage:	10.8V
Charge Temp.:	0~+50°C
Discharge Temp.:	-20~+60°C
Working Humidity:	<95%R.H (non-condensing)
Cycle Life (25°C,0.5C,100%DOD):	>2000
Cell configuration:	53173200-4S1P
Terminal:	F12(M8)
IP Grade:	IP65
Dimension:	522*240*218mm
Weight:	26Kg
Certificates:	UN38.3/MSDS

Different Rate Discharge Curve

Different Rate Discharge Curve @25°C

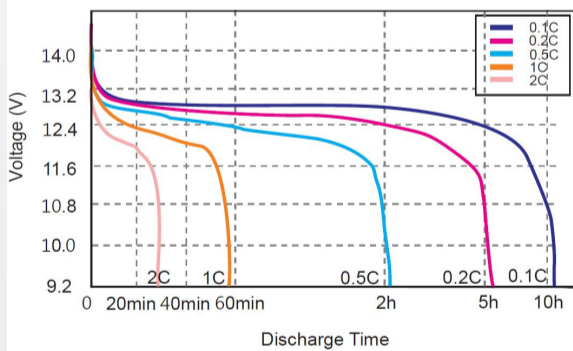

Different Temperature Discharge Curve

Different Temperature Discharge Curve @0.5C

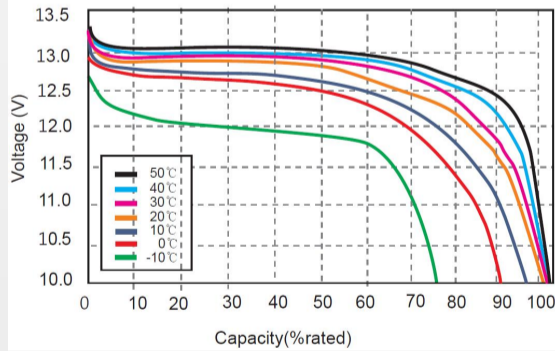

State of Charge Curve

State of Charge Curve @0.5C 25°C

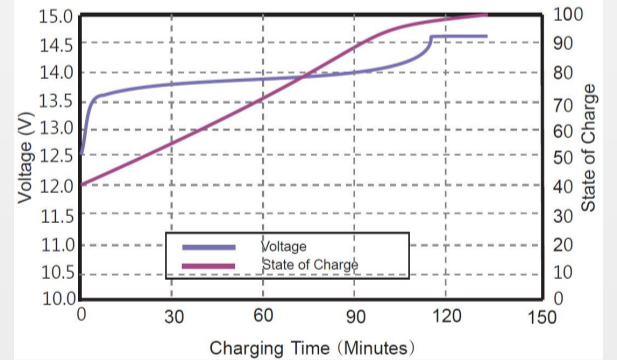

Charging Characteristics

Charging Characteristics @0.5C 25°C

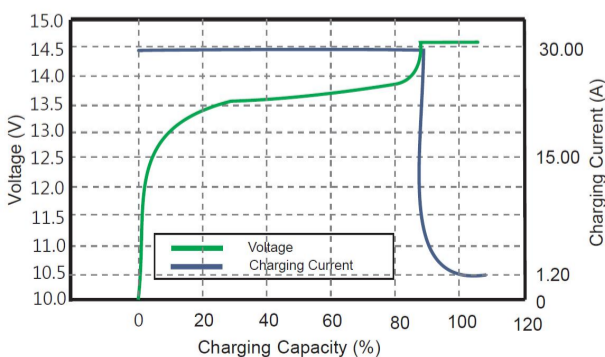

Cycle Life Curve

Different DOD Discharge Cycle Life Curve @1C

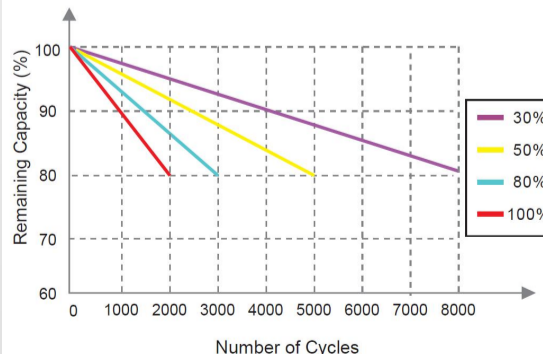

Self Discharge Characteristics Curve

Different Temperature Self Discharge Curve

